

# MaxMotion

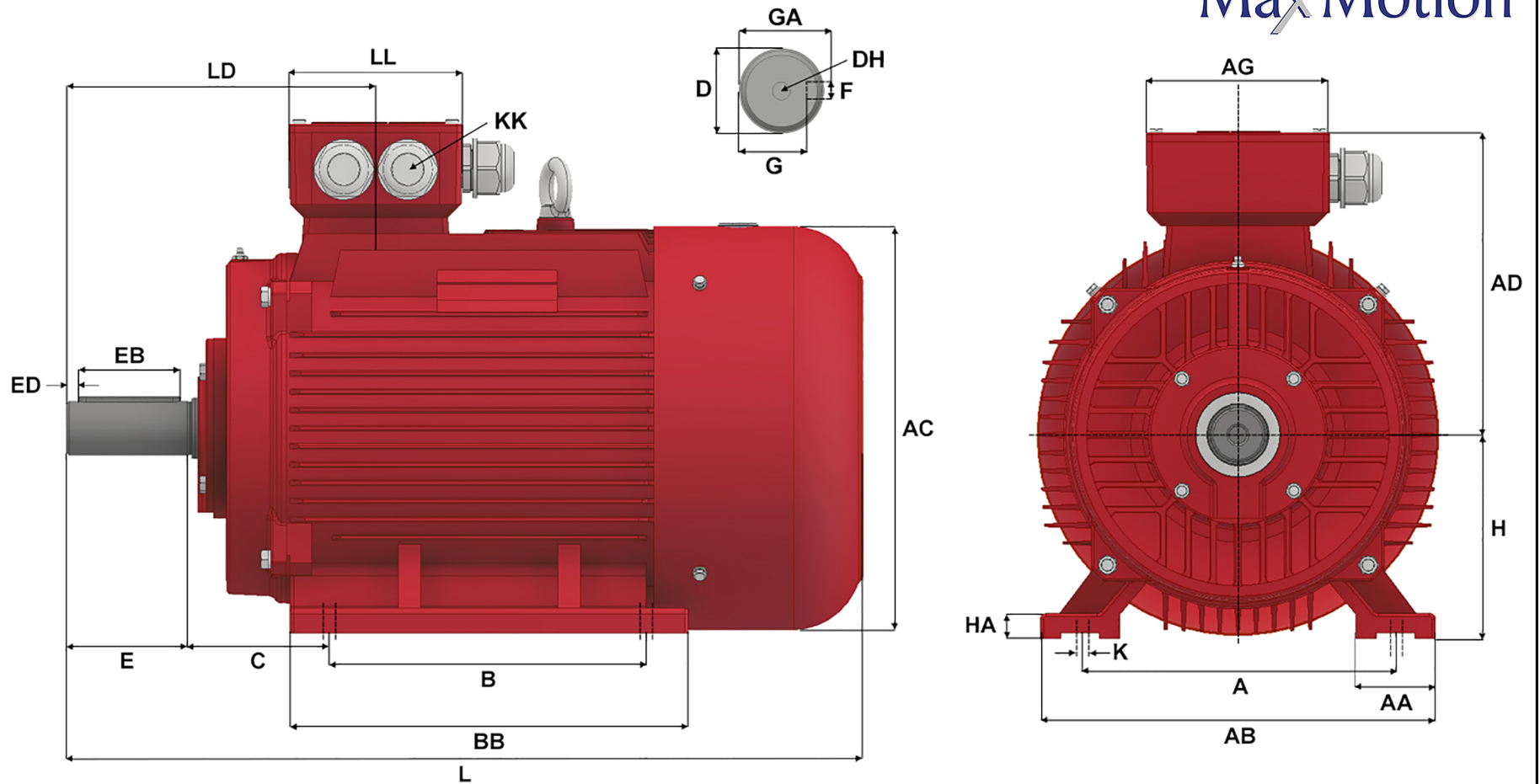

Version: 1JLEM		Revised: 09-11-2019				HP	RPM	FRAME	ENCLOSURE	IJC250M-6-B3			
Customer is responsible in determining that Max Motion product will fit/perform suitably in the intended application						50	1180	250M	TEFC				
A	B	C	D	E	F	G	H	K	L	AA	AB	AC	
406	349	168	65	140	18	53	250	4 - Ø 24	900	80	484	485	
AD	AG	BA	BB	DH	EB	ED	GA	HA	KK (1)	KK (2)	KK (3)	LD	
358	248	0	445	M20 X 42	125	7.5	69	30	M63 X 1.5	2" NPT	M16 X 1.5	347	
LL													
218													